

The Blockchain Based Smart Water Harvesting System

Gokila .R¹, G.Arockiyanathan²

PG Student, Master of Computer Applications, AV S Engineering College, Salem, Tamil Nadu, India¹

Assistant Professor, Artificial Intelligence and Data Science, AVS Engineering College, Salem, Tamil Nadu, India²

ABSTRACT: The Blockchain-Based Smart Water Harvesting System is an intelligent solution designed to efficiently monitor and manage water resources using IoT technology. It uses an ESP32 microcontroller to collect and process data from various sensors. A soil moisture sensor helps determine irrigation needs by measuring soil conditions. Water level and ultrasonic sensors monitor storage levels in tanks and harvesting units. A temperature sensor tracks environmental factors affecting water usage. The system displays real-time data on an LCD for easy monitoring. Blockchain integration ensures secure, transparent, and tamper-proof data storage. This enhances reliability and trust in water usage records. The system supports smart decision-making for water conservation. Overall, it provides an automated, efficient, and sustainable approach to water management.

I. INTRODUCTION

This system presents a structured workflow for collecting, processing, and managing sensor-based data in a monitoring environment. The process begins with sensor data collection, where sensors gather real-time information from the environment. The collected data is then sent to a data processing and control unit that analyzes and organizes the information for meaningful use. After processing, the system provides display and notification outputs to inform users about system status or alerts. The processed data is securely stored using blockchain technology, ensuring transparency, integrity, and protection against unauthorized modification. Furthermore, the system supports continuous monitoring and management to maintain system performance and reliability. By integrating sensing, processing, secure storage, and monitoring, the framework provides an efficient and trustworthy data management solution. This approach improves data security, traceability, and overall system efficiency in smart monitoring applications.

OBJECTIVES

- The system aims to gather environmental or operational data using sensors. This ensures accurate and continuous monitoring of system conditions.
- The objective is to analyze sensor data using a processing unit. This helps in making quick decisions and controlling system operations.
- The system is designed to present processed information to users. It also sends alerts or notifications when abnormal conditions occur.
- The objective is to store important data in a secure and tamper-proof manner. Blockchain technology helps maintain transparency and data integrity.
- The system supports continuous tracking of performance and system status. This helps administrators manage operations and maintain reliability.

II. LITERATURE SURVEY

1. Sharma and P. Verma (2019) IoT-Based Smart Irrigation System

In this research, the authors proposed an IoT-based irrigation system that uses soil moisture sensors to monitor soil conditions. The system automatically controls water supply based on real-time data collected through sensors. Data is transmitted to a cloud platform for remote access and monitoring. Their work demonstrated efficient water usage and reduced wastage through automation and smart decision-making.

2. M. Patel and R. Shah (2020) Smart Water Level Monitoring System Using IoT

In this study, the authors developed a water level monitoring system using ultrasonic sensors and microcontrollers. The system tracks water levels in tanks and sends data to a mobile application via Wi-Fi. Alerts are generated when water

reaches critical levels. Their work highlighted the importance of real-time monitoring in effective water resource management.

3. **S. Gupta and K. Rao (2021) Blockchain-Based Water Management System**

In this research, the authors introduced a blockchain-based approach to securely store and manage water usage data. The system ensures transparency and prevents data tampering. Smart contracts were used to automate water distribution processes. Their work demonstrated how blockchain improves trust and accountability in water management systems.

4. **L. Chen and Y. Wang (2022) IoT and Blockchain Integrated Smart Water System**

In this study, the authors combined IoT sensors with blockchain technology for secure water monitoring. Sensors collect environmental and water data, which is stored on a blockchain network. This ensures data integrity and secure sharing among stakeholders. Their work showed improved reliability and efficiency in smart water systems.

5. **D. Kumar and H. Joshi (2023) Automated Rainwater Harvesting System Using Sensors**

In this research, the authors proposed an automated rainwater harvesting system using water level and rain sensors. The system controls valves and storage based on collected data. Real-time information is displayed and monitored remotely. Their work emphasized sustainable water conservation through automation and smart technologies.

III. EXISTING & PROPOSED SYSTEM

EXISTING SYSTEM

Existing systems for water management mainly rely on IoT-based monitoring and automation techniques. These systems use sensors such as soil moisture, water level, and temperature sensors to collect real-time data for efficient water usage. Data is typically transmitted to cloud platforms for remote monitoring and control. Some systems include automated irrigation and alert mechanisms to reduce water wastage. However, most existing solutions lack strong data security and transparency, making them vulnerable to data tampering and unauthorized access. They also have limited integration of advanced technologies for reliable data sharing. Overall, while current systems improve efficiency, they do not fully ensure secure and trustworthy water resource management.

PROPOSED SYSTEM

The proposed Blockchain-Based Smart Water Harvesting System integrates IoT and blockchain technology to provide a secure and efficient solution for water management. It uses an ESP32 microcontroller along with sensors such as soil moisture, water level, ultrasonic, and temperature sensors to collect real-time data. The system monitors water usage and storage conditions and displays the information on an LCD. Blockchain technology is incorporated to store data securely, ensuring transparency and preventing tampering. This enhances data reliability and enables better decision-making for water conservation. The system operates automatically, reducing manual effort and improving efficiency. Overall, it offers a smart, secure, and sustainable approach to water harvesting and management.

BLOCK DIAGRAM

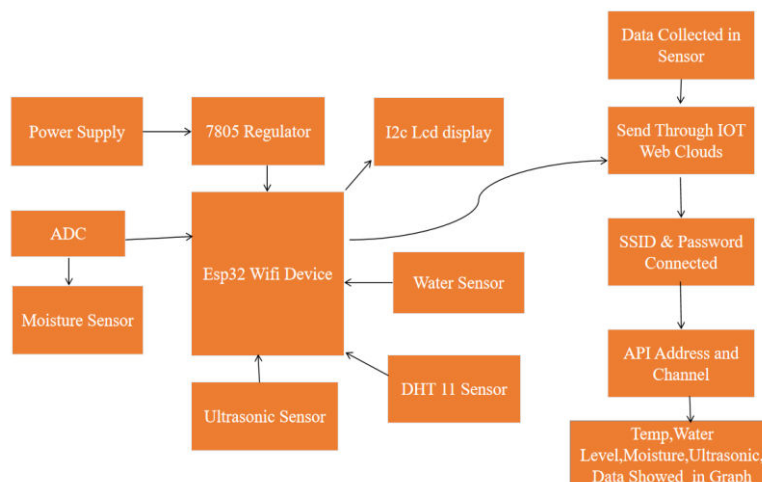

Fig No: 1 Hardware & Software block diagram

IV. HARDWARE REQUIREMENTS

1. POWER SUPPLY

A power supply is an electrical device that converts electric current from a source (such as a wall outlet) into the correct voltage, current, and frequency required to power a specific load (electronic components). Often called power converters, they ensure devices receive stable, usable power while protecting against surges.



Fig No: 2 Power Supply

2. IC 7805 REGULATOR

The IC 7805 is a popular three-terminal linear voltage regulator that provides a fixed +5V DC output from a higher input voltage (typically 7V-35V). It is widely used in electronics for stable power supplies, delivering up to 1.5A current while featuring built-in short-circuit and thermal overload protection.

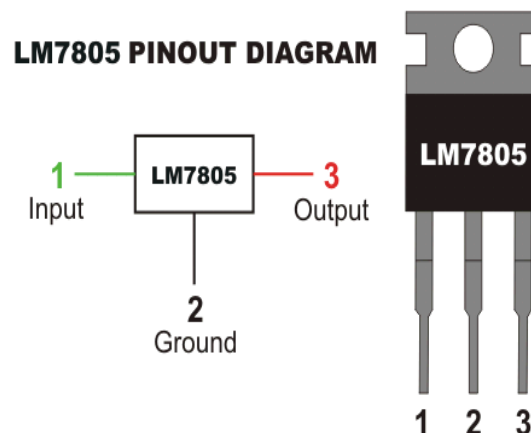

Fig No: 3 IC 7805 REGULATOR

3. ESP32

The ESP32 is a powerful, low-cost, and energy-efficient System on Chip (SoC) developed by Espressif Systems. It is widely used in Internet of Things (IoT) applications due to its dual-core processor, built-in Wi-Fi and Bluetooth connectivity, and rich peripheral interfaces. The ESP32 has become one of the most preferred modules for modern embedded projects requiring wireless data communication, cloud connectivity, and remote monitoring.



Fig No: 4 ESP32

4. LCD Display

An LCD (Liquid Crystal Display) is a thin, flat-panel display technology that uses the light-modulating properties of liquid crystals, sandwiched between polarizers and electrodes, to display images or text. It acts as a digital shutter system—not emitting light directly but instead manipulating backlight (via LEDs) or reflected light to create visual output.



Fig No:5 LCD Display

5. ADC

An Analog-to-Digital Converter (ADC) transforms continuous analog signals (like sound, light, or temperature) into discrete digital data, allowing microcontrollers and computers to process real-world information. Common examples include audio recording (microphones), digital cameras, medical imaging (MRI), and sensor data in automotive system.

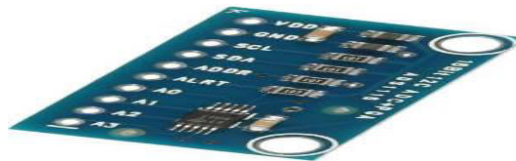

Fig No:6 ADC Analog-to-Digital Converter

6. Moisture Sensor

A moisture sensor measures the water content in materials like soil, air, or industrial products. It commonly uses resistive or capacitive technologies to detect moisture levels, helping to optimize irrigation, monitor humidity, or control drying processes. These sensors are crucial for agriculture, Gardening, and automation.

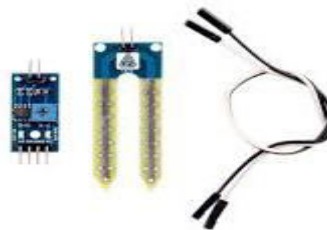

Fig No: 7 Moisture Sensor

7. Ultrasonic Sensor

An ultrasonic sensor is an electronic device that measures the distance to an object by emitting high-frequency sound waves (ultrasonic pulses) and calculating the time it takes for the echo to reflect back. Often used for proximity sensing, obstacle detection, and liquid level measurement, these sensors work in dark or dirty environments where light-based sensors might fail.

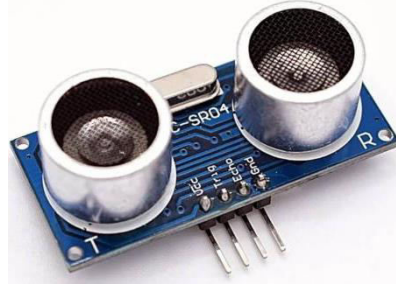

Fig No: 8 Ultrasonic Sensor

8. DHT 11 Sensor

The DHT11 is a low-cost, digital temperature and humidity sensor that utilizes a capacitive sensor element and a thermistor to measure surrounding air, outputting a 40-bit serial digital signal. It operates within 0-50°C and 20-90% RH ranges, providing reliable and economical data for hobbyist projects like Arduino-based weather stations.

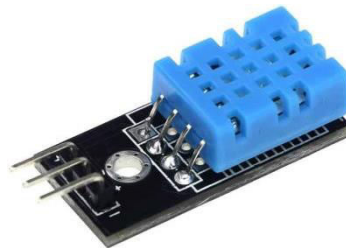

Fig No: 9 DHT 11 Sensor

9. Water Sensor

A water sensor is an electronic device designed to detect the presence, level, or quality of water (or other conductive liquids) and convert this information into a usable electrical signal. These sensors are crucial for automating water management, preventing leaks and floods, and monitoring water levels in tanks, agricultural systems, and industrial processes.

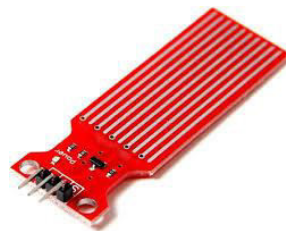
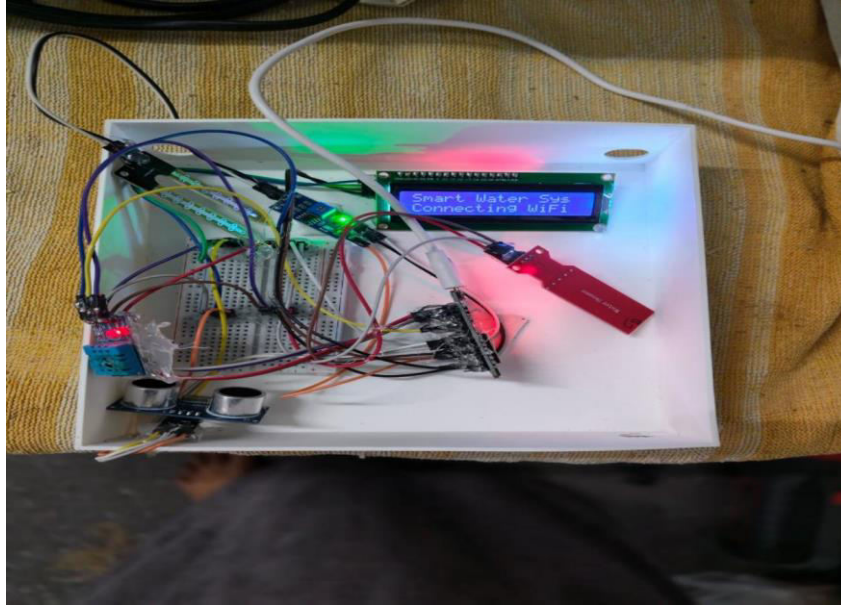

Fig No: 10 Water Sensor

V. RESULT

The proposed Blockchain-Based Smart Water Harvesting System demonstrate efficient and reliable water management through real-time monitoring and automation. The system successfully collects data from soil moisture, water level, ultrasonic, and temperature sensors, providing accurate information for decision-making. It effectively reduces water wastage by optimizing irrigation and storage processes. The integration of blockchain ensures secure, transparent, and tamper-proof data storage, improving trust and reliability. Real-time data display on the LCD enhances user interaction and monitoring. Overall, the system achieves improved water conservation, reduced manual effort, and enhanced efficiency, making it a sustainable solution for smart water management..

**Fig no:11 Project screen shot**

VI. CONCLUSION

The Blockchain-Based Smart Water Harvesting System provides an efficient and intelligent solution for monitoring and managing water resources using modern technologies. The system integrates IoT sensors with the ESP32 microcontroller to collect real-time environmental data. Sensors such as the soil moisture sensor, water sensor, temperature sensor, and ultrasonic sensor continuously monitor important parameters related to water harvesting. The collected data is processed by the ESP32 and displayed on the LCD screen for easy monitoring. This allows users to understand soil conditions, water levels, and temperature changes instantly. The system helps reduce water wastage by providing accurate information about irrigation needs. Another important feature of the system is the use of blockchain technology for secure and transparent data storage. The stored data cannot be easily altered, which ensures reliability and trust in the monitoring process. This feature also helps maintain long-term records of water usage and environmental conditions.

REFERENCES

1. Sharma, P. Verma, and R. Mehta, "IoT-Based Smart Irrigation System for Efficient Water Management," *International Journal of Engineering Research & Technology (IJERT)*, vol. 8, no. 6, pp. 120–125, 2019.
2. M. Patel and R. Shah, "Smart Water Level Monitoring System Using IoT and Wireless Sensors," *International Journal of Innovative Technology and Exploring Engineering (IJITEE)*, vol. 9, no. 4, pp. 45–50, 2020.
3. S. Gupta and K. Rao, "Blockchain-Based Secure Water Management System," *International Journal of Computer Applications*, vol. 176, no. 20, pp. 30–35, 2021.
4. L. Chen and Y. Wang, "Integration of IoT and Blockchain for Smart Water Management," *IEEE Access*, vol. 10, pp. 55678–55685, 2022.
5. D. Kumar and H. Joshi, "Automated Rainwater Harvesting System Using IoT Sensors," *International Journal of Scientific Research in Engineering and Management (IJSREM)*, vol. 7, no. 2, pp. 15–20, 2023.
6. R. Singh and V. Kumar, "Real-Time Water Quality and Level Monitoring Using IoT," *International Journal of Advanced Research in Computer Science*, vol. 11, no. 3, pp. 98–103, 2020.
7. P. Nair and S. Iyer, "Secure Data Management in IoT Using Blockchain Technology," *Journal of Network and Computer Applications*, vol. 150, pp. 102–110, 2021.
8. K. Reddy and M. Srinivas, "Smart Water Conservation System Using Embedded Systems and IoT," *International Journal of Engineering and Advanced Technology (IJEAT)*, vol. 9, no. 5, pp. 200–205, 2020.



INTERNATIONAL
STANDARD
SERIAL
NUMBER
INDIA



INTERNATIONAL JOURNAL OF INNOVATIVE RESEARCH

IN SCIENCE | ENGINEERING | TECHNOLOGY

 9940 572 462  6381 907 438  ijirset@gmail.com



www.ijirset.com

Scan to save the contact details